



Agilent HSSR-7110, HSSR-7111 & HSSR-7112, HSSR-711E

5962-9314001, 5962-9314002

90 V/1.0 Ω , Hermetically Sealed, Power MOSFET Optocoupler

Technical Data

Description

The HSSR-7110, HSSR-7111, HSSR-7112, HSSR-711E and SMD 5962-93140 are single channel power MOSFET optocouplers, constructed in eight-pin, hermetic, dual-in-line, ceramic packages. The devices operate exactly like a solid-state relay.

The products are capable of operation and storage over the full military temperature range and may be purchased as a standard product (HSSR-7110), with full MIL-PRF-38534 Class H testing (HSSR-7111 and HSSR-7112), with MIL-PRF-38534 Class E testing (Class K

with exceptions) (HSSR-711E) or from the DSCC Standard Microcircuit Drawing (SMD) 5962-93140. Details of the Class E program may be found on page 11 of this datasheet.

Applications

- Military and Space
- High Reliability Systems
- Standard 28 Vdc and 48 Vdc Load Driver
- Standard 24 Vac Load Driver
- Aircraft Controls
- ac/dc Electromechanical and Solid State Relay Replacement
- I/O Modules
- Harsh Industrial Environments

Features

- Dual Marked with Device Part Number and DSCC Standard Microcircuit Drawing
- ac/dc Signal & Power Switching
- Compact Solid-State Bidirectional Switch
- Manufactured and Tested on a MIL-PRF-38534 Certified Line
- QML-38534
- MIL-PRF-38534 Class H
- Modified Space Level Processing Available (Class E)
- Hermetically Sealed 8-Pin Dual In-Line Package
- Small Size and Weight
- Performance Guaranteed over -55°C to $+125^{\circ}\text{C}$
- Connection A 0.8 A, 1.0 Ω
- Connection B 1.6 A, 0.25 Ω
- 1500 Vdc Withstand Test Voltage
- High Transient Immunity
- 5 Amp Output Surge Current

Functional Diagrams

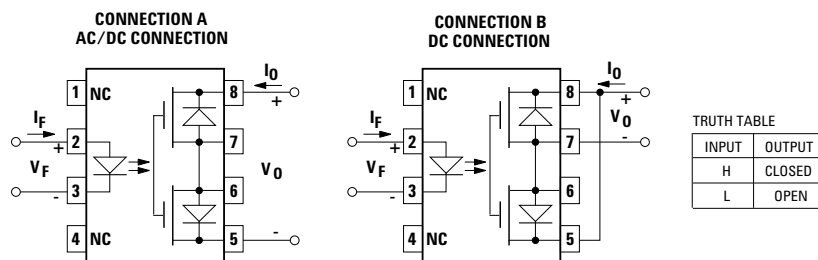

TRUTH TABLE	
INPUT	OUTPUT
H	CLOSED
L	OPEN

CAUTION: It is advised that normal static precautions be taken in handling and assembly of this component to prevent damage and/or degradation which may be induced by ESD.

All devices are manufactured and tested on a MIL-PRF-38534 certified line and are included in the DSCC Qualified Manufacturers List, QML-38534 for Hybrid Microcircuits. Each device contains an AlGaAs light emitting diode optically coupled to a photovoltaic diode stack which drives two discrete power MOSFETs. The device operates as a solid-state replacement for single-pole, normally open, (1 Form A) relays used for general purpose switching of signals and loads in high reliability applications.

The devices feature logic level input control and very low output on-resistance, making them suitable for both ac and dc loads. Connection A, as shown in the Functional Diagram, allows the device to switch either ac or dc loads. Connection B, with the polarity and pin configuration as shown, allows the device to switch dc loads only. The advantage of Connection B is that the on-resistance is significantly reduced, and the output current capability increases by a factor of two.

The devices are convenient replacements for mechanical and solid state relays where high component reliability with standard footprint lead configuration is desirable. Devices may be purchased with a variety of lead bend and plating options. See Selection Guide table for details. Standard Microcircuit Drawing (SMD) parts are available for each package and lead style.

The HSSR-7110, HSSR-7111, HSSR-7112, HSSR-711E and SMD 5962-93140 are designed to switch loads on 28 Vdc power systems. They meet 80 V surge and ± 600 V spike requirements.

Selection Guide—Package Styles and Lead Configuration Options

Agilent Part Number and Options			
Commercial	HSSR-7110		
MIL-PRF-38534 Class H	HSSR-7111	HSSR-7112	
MIL-PRF-38534 Class E			HSSR-711E
Standard Lead Finish	Gold Plate	Gold Plate	Gold Plate
Solder Dipped*	Option #200	Option -200	Option -200
Butt Joint/Gold Plate	Option #100	Option -100	
Gull Wing/Soldered*	Option #300	Option -300	
Crew Cut/Gold Plate	Option #600		
SMD Part #			
Prescript for all below	5962-	5962-	
Either Gold or Soldered	9314001HPX	9314002HPX	9314001EPX
Gold Plate	9314001HPC	9314002HPC	9314001EPC
Solder Dipped*	9314001HPA	9314002HPA	9314001EPA
Butt Joint/Gold Plate	9314001HYC	9314002HYC	
Butt Joint/Soldered*	9314001HYA	9314002HYA	
Gull Wing/Soldered*	9314001HXA	9314002HXA	
Crew Cut/Gold Plate	9314001HZC		
Crew Cut/Soldered*	9314001HZA		

* Solder Contains Lead

CAUTION: Maximum Switching Frequency - Care should be taken during repetitive switching of loads so as not to exceed the maximum output current, maximum output power dissipation, maximum case temperature, and maximum junction temperature.

Outline Drawing

8-pin DIP Through Hole

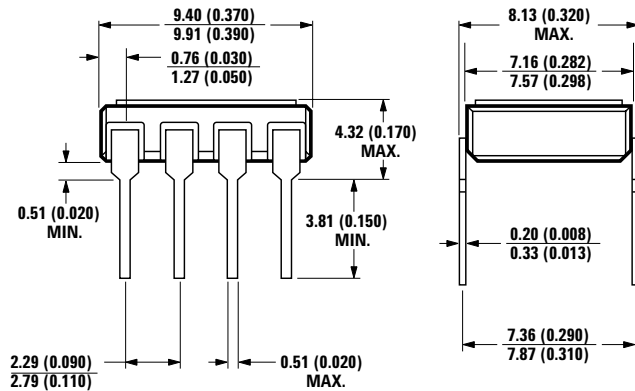

NOTE: DIMENSIONS IN MILLIMETERS (INCHES).

Device Marking

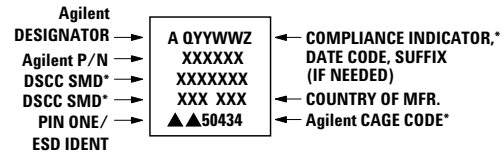

* QUALIFIED PARTS ONLY

Thermal Resistance

Maximum Output MOSFET Junction to Case – $\theta_{JC} = 15^{\circ}\text{C/W}$

ESD Classification

(MIL-STD-883, Method 3015) (▲▲), Class 2

Absolute Maximum Ratings

Parameter	Symbol	Min.	Max.	Units	Note
Storage Temperature Range	T_S	-65°	+150°	C	
Operating Ambient Temperature	T_A	-55°	+125°	C	
Junction Temperature	T_J		+150°	C	
Operating Case Temperature	T_C		+145°	C	1
Lead Solder Temperature (1.6 mm below seating plane)			260° for 10 s	C	
Average Input Current	I_F		20	mA	
Peak Repetitive Input Current (Pulse Width < 100 ms; duty cycle < 50%)	I_{FPK}		40	mA	
Peak Surge Input Current (Pulse Width < 0.2 ms; duty cycle < 0.1%)	$I_{FPK \text{ surge}}$		100	mA	
Reverse Input Voltage	V_R		5	V	
Average Output Current - Figure 2					
Connection A	I_O		0.8	A	
Connection B			1.6	A	
Single Shot Output Current - Figure 3					
Connection A (Pulse width < 10 ms)	$I_{OPK \text{ surge}}$		5.0	A	
Connection B (Pulse width < 10 ms)			10.0	A	
Output Voltage					
Connection A	V_O	-90	90	V	
Connection B		-90	90	V	
Average Output Power Dissipation - Figure 4			800	mW	2

Recommended Operating Conditions

Parameter	Symbol	Min.	Max.	Units	Note
Input Current (on)	$I_{F(ON)}$	5	20	mA	10
Input Current (on)	$I_{F(ON)}$	10	20	mA	11
Input Voltage (off)	$V_{F(OFF)}$	0	0.6	V	
Operating Temperature	T_A	-55°	+125°	C	

Hermetic Optocoupler Options

Note: Dimensions in millimeters (inches).

Option	Description
100	Surface mountable hermetic optocoupler with leads trimmed for butt joint assembly. This option is available on commercial and hi-rel product. <div style="text-align: center;"> </div>
200	Lead finish is solder dipped rather than gold plated. This option is available on commercial and hi-rel product. DSCC Drawing part numbers contain provisions for lead finish.
300	Surface mountable hermetic optocoupler with leads cut and bent for gull wing assembly. This option is available on commercial and hi-rel product. This option has solder dipped leads. <div style="text-align: center;"> </div>
600	Surface mountable hermetic optocoupler with leads trimmed for butt joint assembly. This option is available on commercial and hi-rel product. <div style="text-align: center;"> </div>

Electrical Specifications

$T_A = -55^\circ\text{C}$ to $+125^\circ\text{C}$, unless otherwise specified. See note 9.

Parameter	Sym.	Group A, Sub-group	Test Conditions	Min.	Typ.*	Max.	Units	Fig.	Notes				
Output Withstand Voltage	$ V_{O(OFF)} $	1, 2, 3	$V_F = 0.6\text{ V}, I_0 = 10\ \mu\text{A}$	90	110		V	5					
Output On-Resistance	$R_{(ON)}$	1, 2, 3	$I_F = 10\text{ mA}, I_0 = 800\text{ mA},$ (pulse duration $\leq 30\text{ ms}$)		0.40	1.0	Ω	6, 7	3, 11				
Connection A										$I_F = 5\text{ mA}, I_0 = 800\text{ mA},$ (pulse duration $\leq 30\text{ ms}$)	1.0	3, 10	
Connection B										$I_F = 10\text{ mA}, I_0 = 1.6\text{ A},$ (pulse duration $\leq 30\text{ ms}$)	0.12	0.25	3, 11
										$I_F = 5\text{ mA}, I_0 = 1.6\text{ A},$ (pulse duration $\leq 30\text{ ms}$)		0.25	3, 10
Output Leakage Current	$I_{O(OFF)}$	1, 2, 3	$V_F = 0.6\text{ V}, V_0 = 90\text{ V}$		10^{-4}	10	μA	8					
Input Forward Voltage	V_F	1, 2, 3	$I_F = 10\text{ mA}$	1.0	1.24	1.7	V	9	11				
			$I_F = 5\text{ mA}$						10				
Input Reverse Breakdown Voltage	V_R	1, 2, 3	$I_R = 100\ \mu\text{A}$	5.0			V						
Input-Output Insulation	I_{I-O}	1	$RH \leq 65\%, t = 5\text{ s},$ $V_{I-O} = 1500\text{ Vdc}, T_A = 25^\circ\text{C}$			1.0	μA		4, 5				
Turn On Time	t_{ON}	9, 10, 11	$I_F = 10\text{ mA}, V_{DD} = 28\text{ V},$ $I_0 = 800\text{ mA}$		1.25	6.0	ms	1, 10, 11, 12, 13	11				
			$I_F = 5\text{ mA}, V_{DD} = 28\text{ V},$ $I_0 = 800\text{ mA}$						6.0	10			
Turn Off Time	t_{OFF}	9, 10, 11	$I_F = 10\text{ mA}, V_{DD} = 28\text{ V},$ $I_0 = 800\text{ mA}$		0.02	0.25	ms	1, 10, 14, 15	11				
			$I_F = 5\text{ mA}, V_{DD} = 28\text{ V},$ $I_0 = 800\text{ mA}$						0.25	10			
Output Transient Rejection	$\left \frac{dV_o}{dt} \right $	9	$V_{PEAK} = 50\text{ V}, C_M = 1000\text{ pF},$ $C_L = 15\text{ pF}, R_M \geq 1\text{ M}\Omega$	1000			V/ μs	17					
Input-Output Transient Rejection	$\left \frac{dV_{io}}{dt} \right $	9	$V_{DD} = 5\text{ V}, V_{I-O(PEAK)} = 50\text{ V},$ $R_L = 20\text{ k}\Omega, C_L = 15\text{ pF}$	500			V/ μs	18					

Typical Characteristics

All typical values are at $T_A = 25^\circ\text{C}$, $I_F(\text{ON}) = 10\text{ mA}$, $V_F(\text{OFF}) = 0.6\text{ V}$ unless otherwise specified.

Parameter	Symbol	Test Conditions	Typ.	Units	Fig.	Notes
Output Off-Capacitance	$C_{O(\text{OFF})}$	$V_0 = 28\text{ V}$, $f = 1\text{ MHz}$	145	pF	16	
Output Offset Voltage	$ V_{OS} $	$I_F = 10\text{ mA}$, $I_0 = 0\text{ mA}$	2	μV	19	7
Input Diode Temperature Coefficient	$\Delta V_F / \Delta T_A$	$I_F = 10\text{ mA}$	-1.4	$\text{mV}/^\circ\text{C}$		
Input Capacitance	C_{IN}	$V_F = 0\text{ V}$, $f = 1\text{ MHz}$	20	pF		8
Input-Output Capacitance	C_{I-O}	$V_{I-O} = 0\text{ V}$, $f = 1\text{ MHz}$	1.5	pF		4
Input-Output Resistance	R_{I-O}	$V_{I-O} = 500\text{ V}$, $t = 60\text{ s}$	10^{13}	Ω		4
Turn On Time With Peaking	t_{ON}	$I_{\text{FPK}} = 100\text{ mA}$, $I_{\text{FSS}} = 10\text{ mA}$, $V_{DD} = 28\text{ V}$, $I_0 = 800\text{ mA}$	0.22	ms	1	6

Notes:

- Maximum junction to case thermal resistance for the device is $15^\circ\text{C}/\text{W}$, where case temperature, T_C , is measured at the center of the package bottom.
- For rating, see Figure 4. The output power P_O rating curve is obtained when the part is handling the maximum average output current I_0 as shown in Figure 2.
- During the pulsed R_{ON} measurement (I_0 duration $< 30\text{ ms}$), ambient (T_A) and case temperature (T_C) are equal.
- Device considered a two terminal device: pins 1 through 4 shorted together and pins 5 through 8 shorted together.
- This is a momentary withstand test, not an operating condition.
- For a faster turn-on time, the optional peaking circuit shown in Figure 1 may be implemented.
- V_{OS} is a function of I_F , and is defined between pins 5 and 8, with pin 5 as the reference. V_{OS} must be measured in a stable ambient (free of temperature gradients).
- Zero-bias capacitance measured between the LED anode and cathode.
- Standard parts receive 100% testing at 25°C (Subgroups 1 and 9). SMD, Class H and Class E parts receive 100% testing at 25°C , 125°C and -55°C (Subgroups 1 and 9, 2 and 10, 3 and 11 respectively).
- Applies to HSSR-7112 and 5962-9314002Hxx devices only.
- Applies to HSSR-7110, HSSR-7111, HSSR-711E, 5962-9314001Hxx and 5962-9314001Exx devices only.

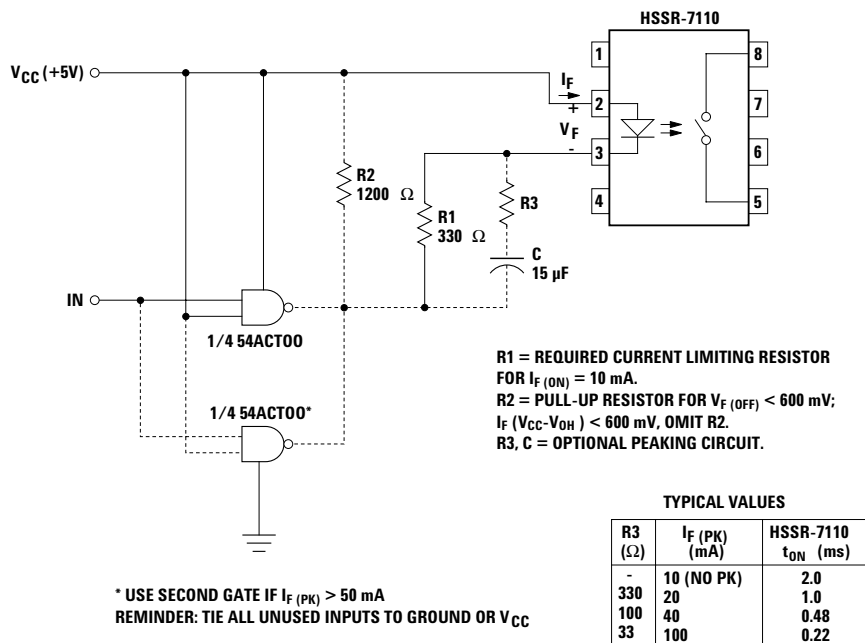

Figure 1. Recommended Input Circuit.

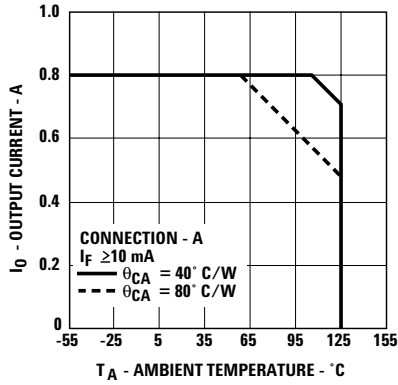

Figure 2. Maximum Average Output Current Rating vs. Ambient Temperature.

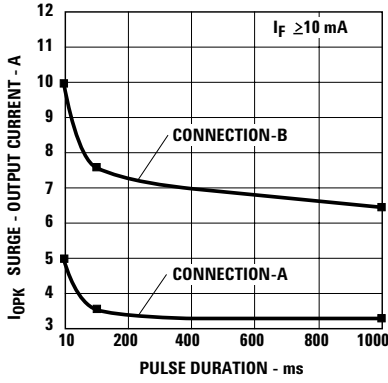

Figure 3. Single Shot (non-repetitive) Output Current vs. Pulse Duration.

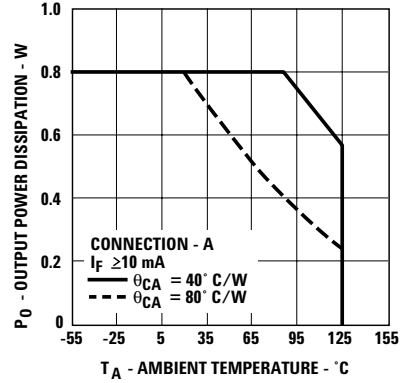

Figure 4. Output Power Rating vs. Ambient Temperature.

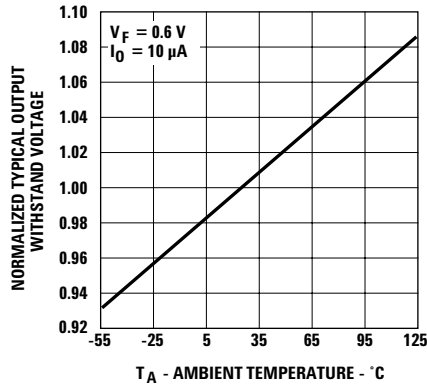

Figure 5. Normalized Typical Output Withstand Voltage vs. Temperature.

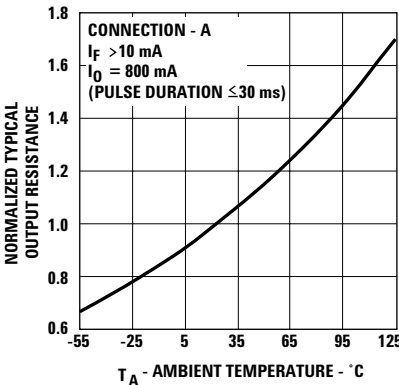

Figure 6. Normalized Typical Output Resistance vs. Temperature.

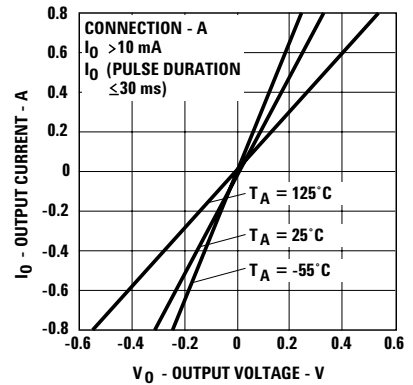

Figure 7. Typical On State Output I-V Characteristics.

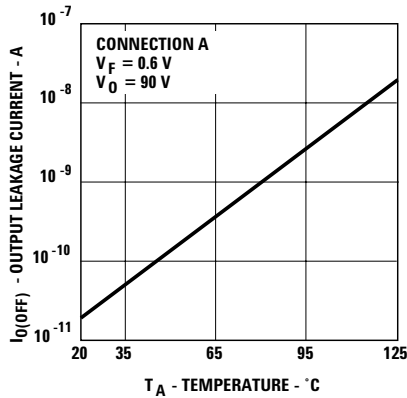

Figure 8. Typical Output Leakage Current vs. Temperature.

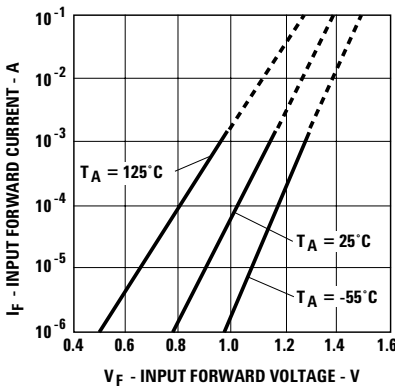

Figure 9. Typical Input Forward Current vs. Input Forward Voltage.

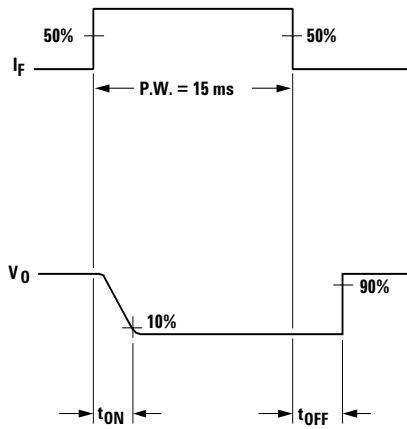

Figure 10. Switching Test Circuit for t_{ON} , t_{OFF} .

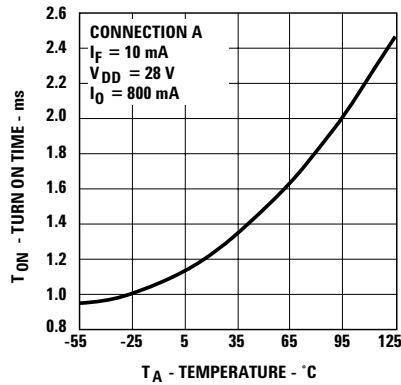
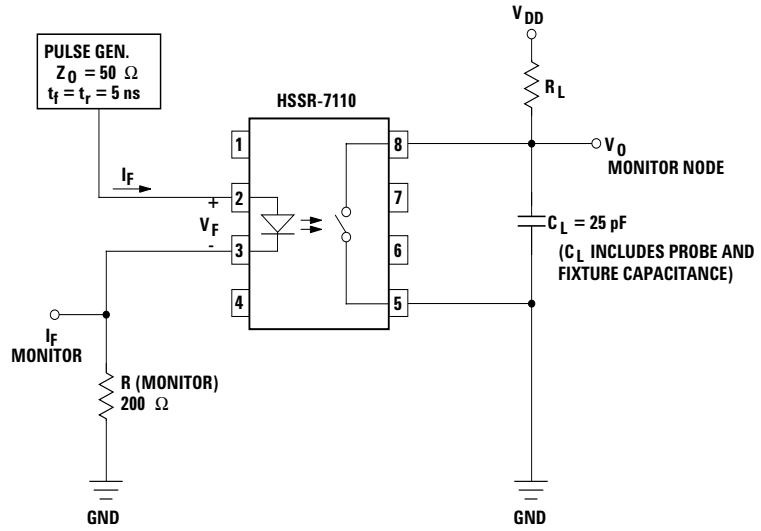

Figure 11. Typical Turn On Time vs. Temperature.

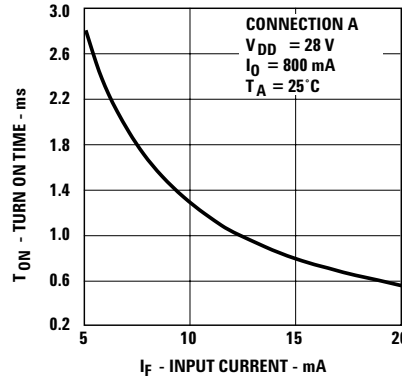

Figure 12. Typical Turn On Time vs. Input Current.

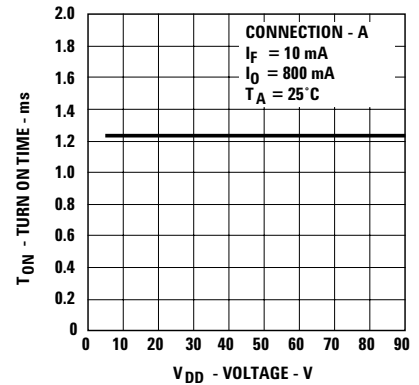

Figure 13. Typical Turn On Time vs. Voltage.

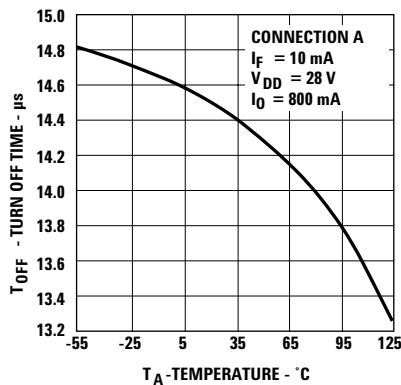

Figure 14. Typical Turn Off Time vs. Temperature.

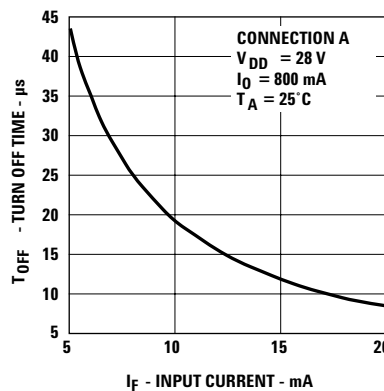

Figure 15. Typical Turn Off Time vs. Input Current.

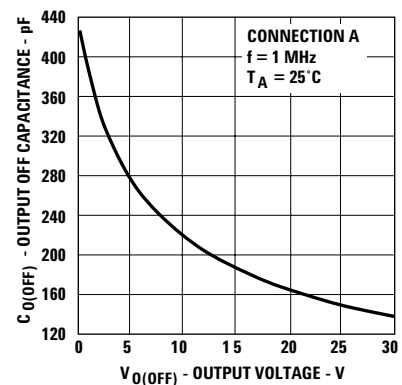

Figure 16. Typical Output Off Capacitance vs. Output Voltage.

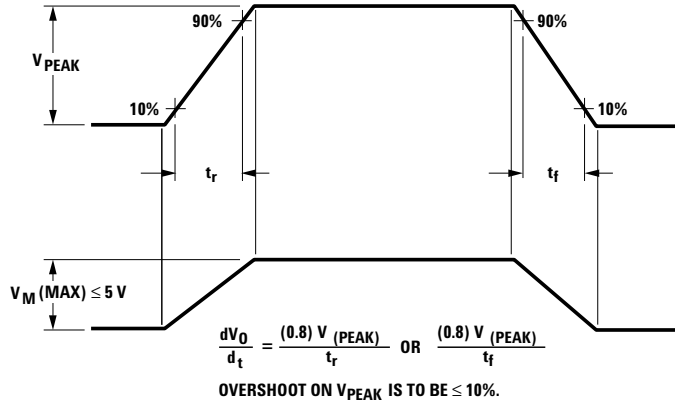
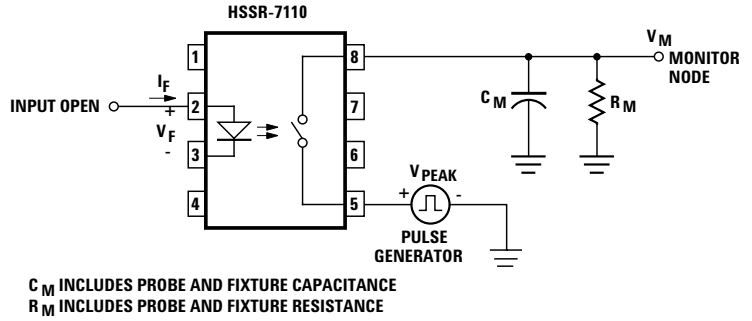

Figure 17. Output Transient Rejection Test Circuit.

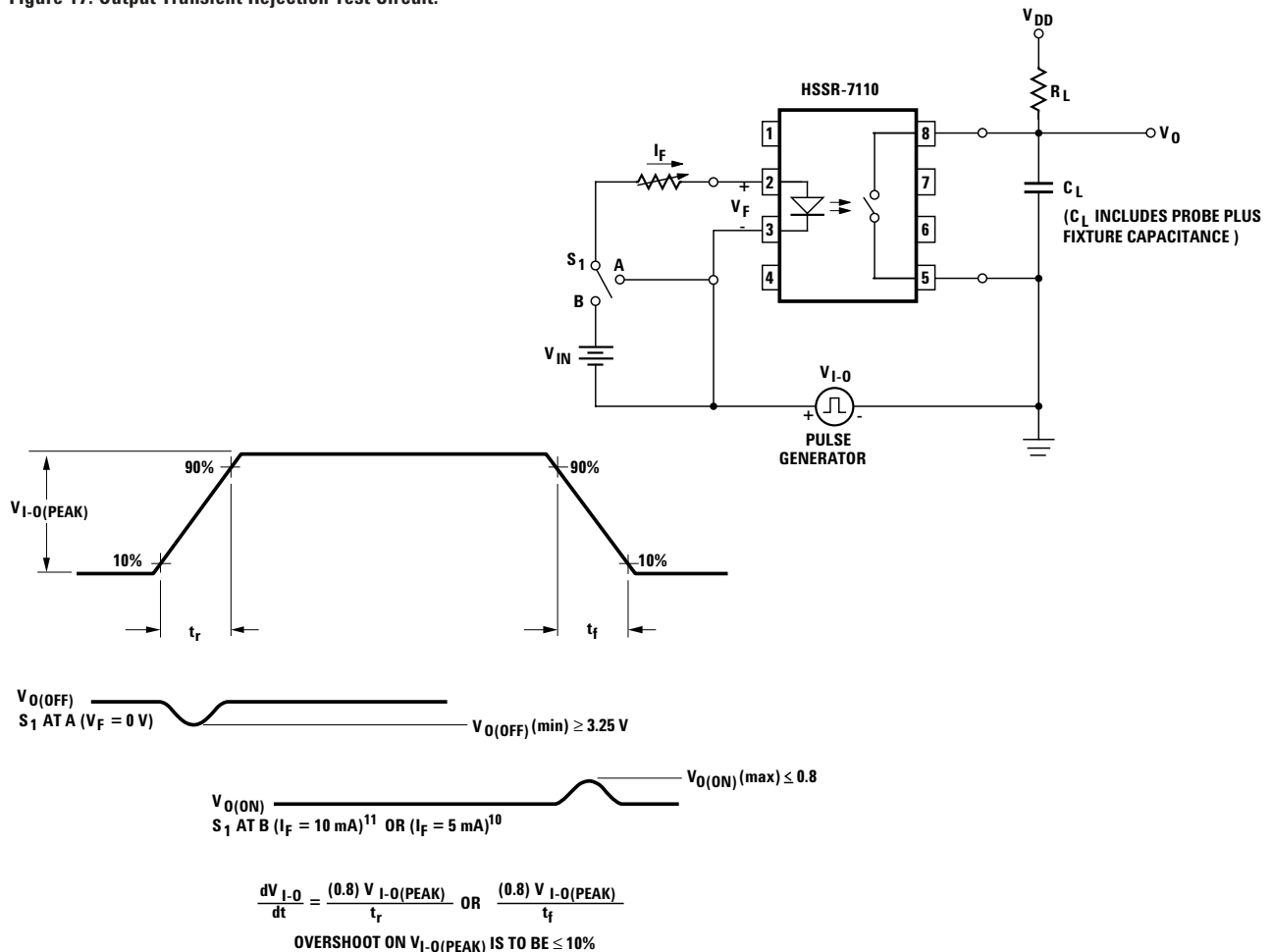

Figure 18. Input-Output Transient Rejection Test Circuit.

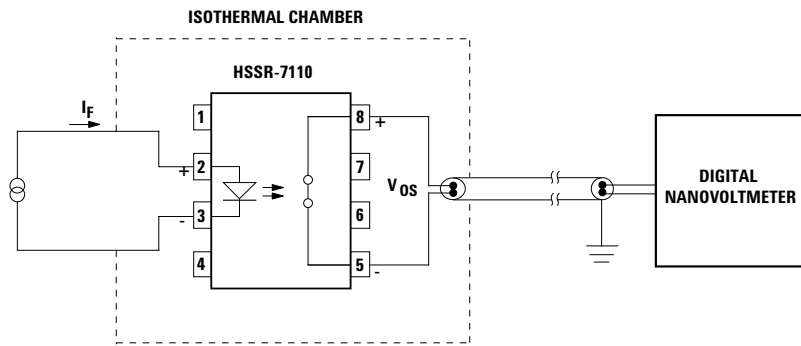
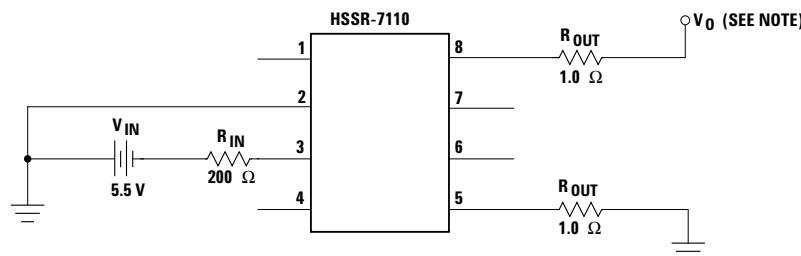

Figure 19. Voltage Offset Test Setup.



NOTE:
IN ORDER TO DETERMINE V_{OUT} CORRECTLY, THE CASE TO AMBIENT THERMAL IMPEDANCE MUST BE MEASURED FOR THE BURN-IN BOARDS TO BE USED. THEN, KNOWING θ_{CA} , DETERMINE THE CORRECT OUTPUT CURRENT PER FIGURES 2 AND 4 TO INSURE THAT THE DEVICE MEETS THE DERATING REQUIREMENTS AS SHOWN.

Figure 20. Burn-In Circuit.

Applications Information

Thermal Model

The steady state thermal model for the HSSR-7110 is shown in Figure 21. The thermal resistance values given in this model can be used to calculate the temperatures at each node for a given operating condition. The thermal resistances between the LED and other internal nodes are very large in comparison with the other terms and are omitted for simplicity. The components do, however, interact indirectly through θ_{CA} , the case-to-ambient thermal resistance. All heat generated flows through θ_{CA} , which raises the case temperature T_C accordingly. The value of θ_{CA} depends on the conditions of the board design and is, therefore, determined by the designer.

The maximum value for each output MOSFET junction-to-case thermal resistance is specified as $15^{\circ}\text{C}/\text{W}$. The thermal resistance from FET driver junction-to-case is also $15^{\circ}\text{C}/\text{W}$. The power dissipation in the FET driver, however, is negligible in comparison to the MOSFETs.

On-Resistance and Rating Curves

The output on-resistance, R_{ON} , specified in this data sheet, is the resistance measured across the output contact when a pulsed current signal ($I_O = 800$ mA) is applied to the output pins. The use of a pulsed signal (≤ 30 ms) implies that each junction temperature is equal to the ambient and case temperatures. The steady-state resistance, R_{SS} , on the other hand, is the value of the resistance measured across the output contact when a DC current signal is applied to the

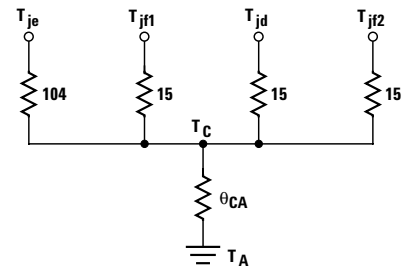

T_{je} = LED JUNCTION TEMPERATURE
 T_{jf1} = FET 1 JUNCTION TEMPERATURE
 T_{jf2} = FET 2 JUNCTION TEMPERATURE
 T_{jd} = FET DRIVER JUNCTION TEMPERATURE
 T_C = CASE TEMPERATURE (MEASURED AT CENTER OF PACKAGE BOTTOM)
 T_A = AMBIENT TEMPERATURE (MEASURED 6" AWAY FROM THE PACKAGE)
 θ_{CA} = CASE-TO-AMBIENT THERMAL RESISTANCE

ALL THERMAL RESISTANCE VALUES ARE IN $^{\circ}\text{C}/\text{W}$

Figure 21. Thermal Model.

output pins for a duration sufficient to reach thermal equilibrium. R_{SS} includes the effects of the temperature rise of each element in the thermal model. Rating curves are shown in Figures 2 and 4. Figure 2 specifies the maximum average output current allowable for a given ambient temperature. Figure 4 specifies the output power dissipation allowable for a given ambient temperature. Above 55°C (for $\theta_{CA} = 80^{\circ}\text{C}/\text{W}$) and 107°C (for $\theta_{CA} = 40^{\circ}\text{C}/\text{W}$), the maximum allowable output current and power dissipation are related by the expression $R_{SS} = P_O(\text{max}) / (I_O(\text{max}))^2$ from which R_{SS} can be calculated. Staying within the safe area assures that the steady-state junction temperatures remain less than 150°C . As an example, for $T_A = 95^{\circ}\text{C}$ and $\theta_{CA} = 80^{\circ}\text{C}/\text{W}$, Figure 2 shows

that the output current should be limited to less than 610 mA. A check with Figure 4 shows that the output power dissipation at $T_A = 95^\circ\text{C}$ and $I_O = 610\text{ mA}$, will be limited to less than 0.35 W. This yields an R_{SS} of 0.94 Ω .

Design Considerations for Replacement of Electro-Mechanical Relays

The HSSR-7110 family can replace electro-mechanical relays with comparable output voltage and current ratings. The following design issues need to be considered in the replacement circuit.

Input Circuit: The drive circuit of the electro-mechanical relay coil needs to be modified so that the average forward current driving the LED of the HSSR-7110 does not exceed 20 mA. A nominal forward drive current of 10 mA is recommended. A recommended drive circuit with 5 volt V_{CC} and CMOS logic gates is shown in Figure 1. If higher V_{CC} voltages are used, adjust the current limiting resistor to a nominal LED forward current of 10 mA. One important consideration to note is that when the LED is turned off, no more than 0.6 volt forward bias should be applied across the LED. Even a few microamps of current may be sufficient to turn on the HSSR-7110, although it may take a considerable time. The drive circuit should maintain at least 5 mA of LED current during the ON condition. If the LED forward current is less than the 5 mA level, it will cause the HSSR-7110 to turn on with a longer delay. In addition, the power dissipation in the output power MOSFETs increases, which, in turn, may

violate the power dissipation guidelines and affect the reliability of the device.

Output Circuit: Unlike electromechanical relays, the designer should pay careful attention to the output on-resistance of solid state relays. The previous section, "On-Resistance and Rating Curves" describes the issues that need to be considered. In addition, for strictly dc applications the designer has an advantage using Connection B which has twice the output current rating as Connection A. Furthermore, for dc-only applications, with Connection B the on-resistance is considerably less when compared to Connection A.

Output over-voltage protection is yet another important design consideration when replacing electro-mechanical relays with the HSSR-7110. The output power MOSFETs can be protected using Metal oxide varistors (MOVs) or TransZorbs against voltage surges that exceed the 90 volt output withstand voltage rating. Examples of sources of voltage surges are inductive load kickbacks, lightning strikes, and electro-static voltages that exceed the specifications on this data sheet. For more information on output load and protection refer to Application Note 1047.

References:

1. Application Note 1047, "Low On-Resistance Solid State Relays for High Reliability Applications."
2. Reliability Data for HSSR-7110.

MOV is a registered trademark of GE/RCA Solid State.

TransZorb is a registered trademark of General Semiconductor.

MIL-PRF-38534 Class H, Class E and DSCC SMD Test Program

Class H:

Agilent Technologies' Hi-Rel Optocouplers are in compliance with MIL-PRF-38534 Class H. Class H devices are also in compliance with DSCC drawing 5962-93140.

Testing consists of 100% screening and quality conformance inspection to MIL-PRF-38534.

Class E:

Class E devices are in compliance with DSCC drawing 5962-9314001Exx. Agilent Technologies has defined the Class E device on this drawing to be based on the Class K requirements of MIL-PRF-38534 with exceptions. The exceptions are as follows:

1. Nondestructive Bond Pull, Test method 2023 of MIL-STD-883 is device screening is not required.
2. Particle Impact Noise Detection (PIND), Test method 2020 of MIL-STD-883 in device screening and group C testing is not required.
3. Die Shear Strength, Test method 2019 of MIL-STD-883 in group B testing is not required.
4. Internal Water Vapor Content, Test method 1018 of MIL-STD-883 in group C testing is not required.
5. Scanning Electron Microscope (SEM) inspections, Test method 2018 of MIL-STD-883 in element evaluation is not required.

**www.agilent.com/
semiconductors**

For product information and a complete list of distributors, please go to our web site.

For technical assistance call:

Americas/Canada: +1 (800) 235-0312
or (408) 654-8675

Europe: +49 (0) 6441 92460

China: 10800 650 0017

Hong Kong: (+65) 6756 2394

India, Australia, New Zealand: (+65) 6755 1939

Japan: (+81 3) 3335-8152(Domestic/International), or 0120-61-1280(Domestic Only)

Korea: (+65) 6755 1989

Singapore, Malaysia, Vietnam, Thailand, Philippines, Indonesia: (+65) 6755 2044

Taiwan: (+65) 6755 1843

Data subject to change.

Copyright © 2004 Agilent Technologies, Inc.

November 18, 2004

5989-1944EN



Agilent Technologies